



快速操作手册

QUICK REFERENCE GUIDE

HM65X DIGITAL MOBILE RADIO



is the trademark or registered trademark of Hytera Communications Corporation Limited.

© 2022 Hytera Communications Corporation Limited. All Rights Reserved.

Address: Hytera Tower, Hi-Tech Industrial Park North, 9108# Beihuan Road, Nanshan District, Shenzhen,  
People's Republic of China

Postcode: 518057

[https:// www.hytera.com](https://www.hytera.com)



5202010081316A

## Product Layout

### HM65X

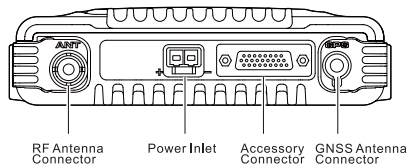
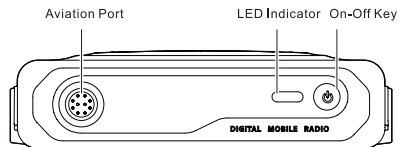

### Palm Microphone

You can request your dealer to program the **Top Key (TK)**, **P1** key, and **P2** key as shortcuts to assignable radio features.

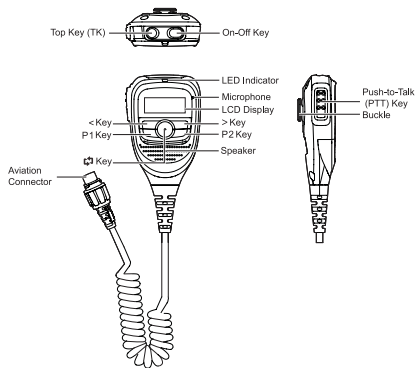

## Installation

### Precautions

Before installation, read the following guidelines carefully:

- Before installation, ensure that the vehicle power supply has a negative ground with the voltage of 13.6±15% V.
- Before installation, measure the length of screws protruding from the radio surface. During installation, drill the holes on the vehicle according to the screw length to avoid damaging the vehicle wires or other components.
- Use the antenna and power cord approved by the Company.
- Use the mounting bracket approved by the Company. Otherwise, the accidental drop of the radio may injure people in the vehicle.
- Install the radio at a position where you can easily reach the front panel.
- To facilitate wiring, keep sufficient space at the back of the radio.
- When replacing the fuse for the DC power cord, ensure the new fuse shares the same specification with the old one.
- If any other communication devices such as repeaters are in the vicinity of the radio, keep the antenna of these devices at least 10 meters away from that of the radio.

### Tools

- electric drill
- Phillips screwdriver
- T20 torx screwdriver

## Parts

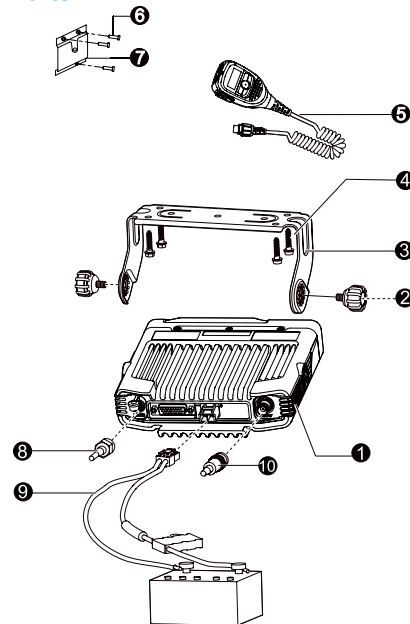

No.	Part Name	No.	Part Name
1	Radio	6	Self-tapping Screw (4 mm x 16 mm)
2	Locking Knobs	7	Microphone Hanger
3	Mounting Bracket	8	GNSS Antenna
4	Self-tapping Screw (4.8 mm x 20 mm)	9	Power Cord (with fuse)
5	Palm Microphone	10	RF Antenna

## NOTE

- The RF antenna is optional.
- The GNSS antenna is available only for radios with the Location feature.

## Procedure

1. Install the radio.
  - a. Select a location on the vehicle.
  - b. Hold the mounting bracket to the location, and then mark the mounting holes.
  - c. Drill holes at the mounting holes.
  - d. Use the screws (4.8 mm x 20 mm) to secure the mounting bracket.
  - e. Connect the RF antenna, GNSS antenna, and power cord to the radio.
  - f. Slide the radio into the mounting bracket, and then fasten the locking knobs.
2. Install the palm microphone.
  - a. Select a location on the vehicle where you can reach the palm microphone easily.
  - b. Hold the microphone hanger to the location, and then mark the mounting holes.
  - c. Drill holes at the mounting holes.
  - d. Use the screws (4 mm x 16 mm) to secure the microphone hanger.
  - e. Align the triangle index on the palm microphone with that on the radio.
  - f. Plug the aviation connector on the palm microphone into the aviation port on the radio, and then rotate the connector clockwise to secure it.
  - g. Place the palm microphone on the hanger.

## Basic Operations

### Turn On or Off the Radio



On the HM65X or the palm microphone, long press the **On-Off** key.

#### NOTE

Upon connection to the power supply, the radio automatically turns on.

### Adjust Volume

You can adjust the volume on the microphone.

- On the home screen, press the < key to decrease the volume or the > key to increase the volume.
- Press the  key to locate the cursor to , and then press the < or > key.

### Select a Zone















- On the home screen, press  key to locate the cursor to the zone No., and then press the < or > key.
- Press the preprogrammed **Zone Up** or **Zone Down** key.

### Select a Channel

- On the home screen, press  key to locate the cursor to the channel No., and then press the < or > key.
- Press the preprogrammed **Channel Up** or **Channel Down** key.
- To direct to the preset channel, press the preprogrammed **Preset Channel** key.

## Status Indications

### LCD Icons

Icon	Description
	The radio detects no signal.
	More bars indicate stronger signal.
	The radio operates in low power mode.
	The radio operates in high power mode.
	An accessory is connected.
	The radio is scanning.
	The radio is roaming.
	The radio is in emergency mode.
	The radio is on a private call.
	The radio is making a private call.
	The radio is receiving a private call.
	The radio is on a group call.
	The radio is making a group call.
	The radio is receiving a group call.

For more status icons, refer to the *User Manual*.



## LED Indicator

LED Indicator	Radio Status
Flashes green	The radio is being turned on.
Glowes green	The radio is receiving.
Glowes red	The radio is transmitting.
Flashes orange slowly	The radio is scanning or roaming.
Flashes orange rapidly	The radio is in emergency mode.
Glowes orange	Call hang time: No voice is being transmitted or received during a call. Within such a period, you can press and hold the <b>PTT</b> key and speak.
Flashes blue	Every 3s The BT feature is enabled, but no BT device is connected.
	Every 1.5s A BT device is connected.
	Every 0.1s The BT feature is being disabled.

### NOTE

BT status is indicated only through the LED indicator on the HM65X.

## Call Services

To ensure optimal voice quality on the receiving radio, keep the microphone 2.5 cm to 5 cm away from your mouth during speaking.

### Make a Call on a Digital Channel

- On the home screen, select a digital channel, and then press and hold the **PTT** key.
- Press the programmed **One Touch Call** key, and then press and hold the **PTT** key.

### Make a Call on an Analog Channel

- Call Without Signaling
  - a. On the home screen, select an analog channel.
  - b. Press and hold the **PTT** key.
- Call with Signaling
  - a. On the home screen, select an analog channel.
  - b. Press the **PTT** key or the preprogrammed **One Touch Call** key.

### Make an Emergency Call

The Emergency feature is configured and enabled by your dealer. For details, refer to the *User Manual*.

For details, please visit our website at: <https://www.hytera.com/en/download-center.html>, or scan the QR code to download the relevant *User Manual*.

